

STIEBEL ELTRON

INSTALLATION REQUIREMENTS AS
PER A.S. 3500.4.2

ELECTRICAL CONNECTION
3 PHASE – 415V HARD WIRED
19.4 kW
27 AMPS PER PHASE

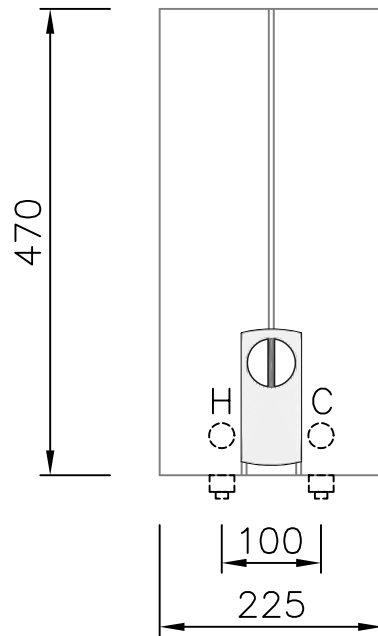

FRONT ELEVATION

1/2 INCH FEMALE
CONNECTIONS FOR INTERIOR
WALL OR 1/2 INCH MALE
FOR EXPOSED LOWER
CONNECTIONS

INCOMING WATER
SUPPLY 20mm

GATE VALVE OR
FULL FLOW VALVE
(max. 1000 Kpa)
(BY OTHERS)

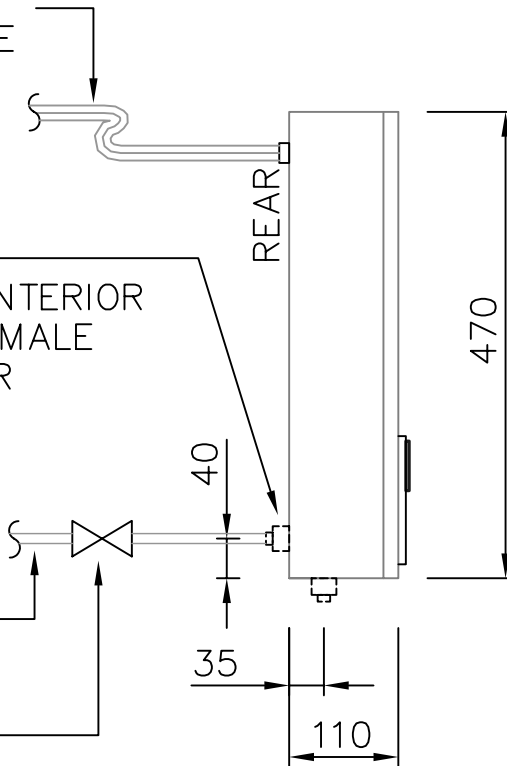

SIDE ELEVATION

NOTE:

IF MAXIMUM 50°C WATER IS REQUIRED, THE
USE OF A HIGH PERFORMANCE TEMPERING
VALVE IS RECOMMENDED. (BY OTHERS)

DHB-E 18